



The HWX series of Gefran are pressure transmitters with HART communication protocol for using in high temperature environment with explosive atmosphere presence.

The main characteristic of this series is the capability to read temperature of the media up to 315°C.

The constructive principle is based on the hydraulic transmission of the pressure.

The fluid-filled system assures the temperature stability. The physical measure is transformed in a electrical measure by means of strain-gauge technology.

MAIN FEATURES

- Pressure ranges from: 0-17 to 0-1000 bar / 0-250 to 0-15000 psi
- Accuracy: $\pm 0.25\%$ FSO (H); $\pm 0.5\%$ FSO (M)
- Fluid-filled system for temperature stability
- Oil filling volume:
HWX0 (30mm³); HWX1, HWX2, HWX3 (40mm³)
- 1/2-20UNF, M18x1.5 standard threads; other types available on request
- Autozero function on board / external option
- 17-7 PH corrugated diaphragm with GTP coating

HWX0 The rigid rod configuration provides fast and easy installation.

HWX1 The flexible rod configuration is suitable for applications demanding greater thermal isolation and where installation would otherwise be difficult.

HWX2 This configuration lets you measure process pressure and temperature at the same point with a single installation.

HWX3 The configuration with exposed tip is ideal for applications in limited space.

Main intrinsic safety characteristics

Transmitter designed and produced in compliance with Directive 94/9/ CE ATEX and according to European standards.

Protection mode: group II, category 1G, 1D

GAS protection mode: Ex ia IIC T6, T5, T4 Ga (Ambient Temp.: -20°C...+60°C / +75°C / +85°C)

DUST protection mode: Ex ia IIIC T85°C, T100°C, T135°C Da IP65 (Ambient Temp.: -20°C...+60°C / +75°C / +85°C)

| | |
|------------------------|--------|
| Maximum voltage | 30 V |
| Maximum current | 100 mA |
| Maximum power | 0,75 W |
| Maximum inductance (*) | 17 µH |
| Maximum capacity (*) | 10 nF |

(*) includes inductance levels and capacity of a cable:
(typical L 1microH/m and typical C 100pF/m) with maximum length 15m.

TECHNICAL SPECIFICATIONS

| | |
|---|--|
| Accuracy (1) | H $\pm 0.25\%$FSO (100...1000 bar) M $\pm 0.5\%$FSO (17...1000 bar) |
| Resolution | 16 bit |
| Measurement range | 0..17 to 0..1000bar 0..250 to 0..15000psi |
| Rangeability | 3:1 |
| Maximum overpressure (without degrading performances) | 2 x FS 1.5 x FS above 500bar/7500psi |
| Measurement principle | Extensimetric |
| Power supply | 13...30Vdc |
| Maximum current absorption | 23mA |
| Output signal Full Scale (FSO) | 20mA |
| Zero balance (tolerance $\pm 0.25\%$ FSO) | 4mA |
| Calibration signal | 80% FSO |
| Power supply polarity reverse protection | YES |
| Compensated temperature range housing | 0...+85°C |
| Operating temperature range housing | -30...+85°C |
| Storage temperature range housing | -40...+125°C |
| Thermal drift in compensated range: Zero / Calibration / Sensibility | <math>< 0.02\%</math> FSO/°C |
| Diaphragm maximum temperature | 315°C / 600°F |
| Zero drift due to change in process temperature (zero) | <math>< 0.04</math> bar/°C |
| Standard material in contact with process medium | Diaphragm: • 17-7 PH corrugated diaphragm with GTP coating Stem: • 17-4 PH |
| Thermocouple (model HWX2) | STD: type "J" (isolated junction) |
| Protection degree (with 6-pole female connector) | IP65 |
| FSO = Full scale output (1) BFSL method (Best Fit Straight Line): includes combined effects of Non-Linearity, Hysteresis and Repeatability | |

The Melt pressure transmitters must be connected to other equipment (galvanic isolation barriers) with individual ATEX certification such as [Ex ia Ga] IIC. The thermocouple circuit must be powered by means of galvanic isolation barriers with a maximum of 30V.



EC-Type Examination Certificate number: **DNV 13 ATEX 3894**

MECHANICAL DIMENSIONS

HWX0

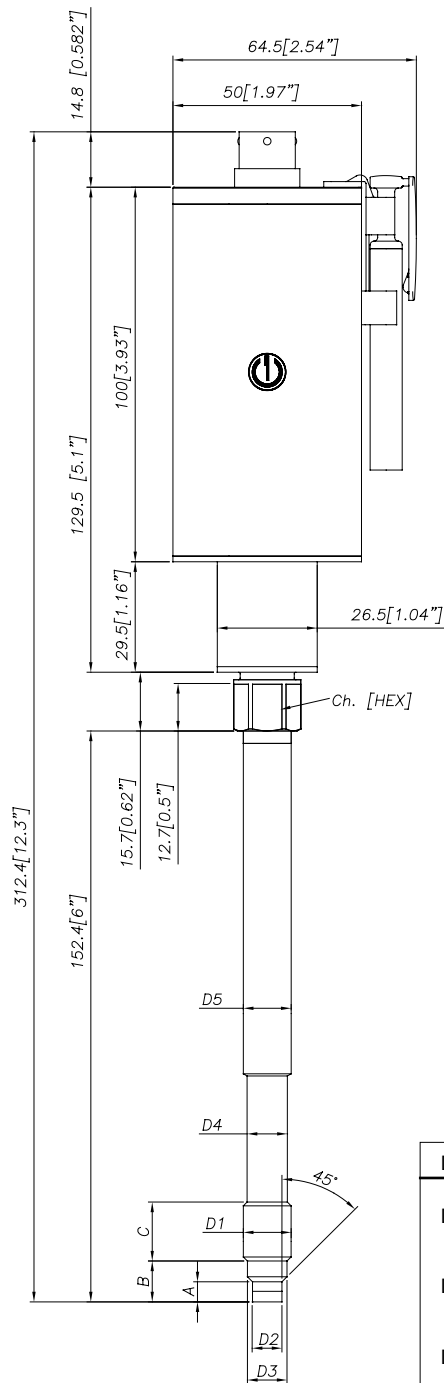

HWX1

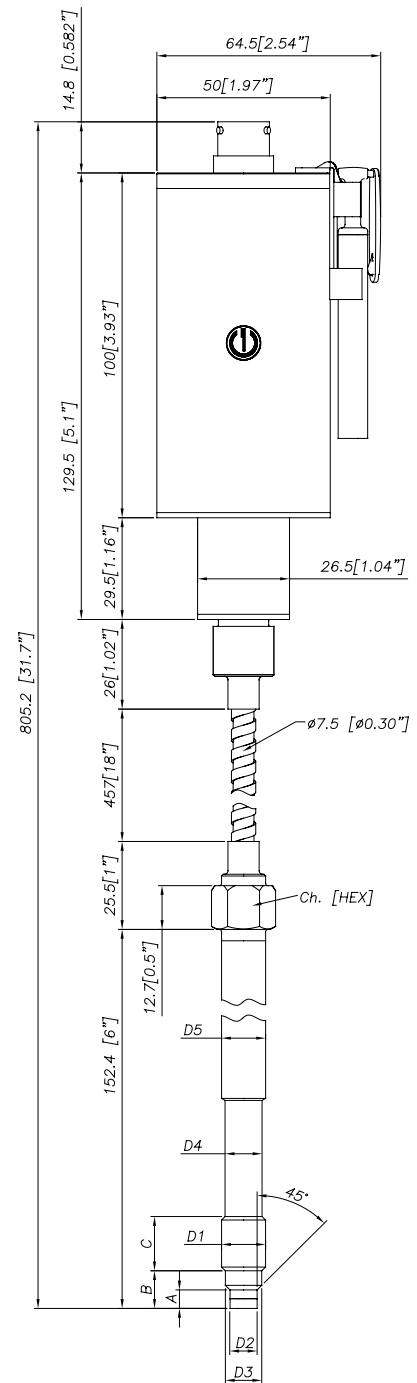

| D1 | 1/2 - 20UNF | D1 | M18x1.5 |
|-------------|---------------------------------|-------------|-------------------------------|
| D2 | ø7.8 -0.05 [ø0.31" -0.002] | D2 | ø10 -0.05 [ø0.394" -0.002] |
| D3 | ø10.5 -0.025 [ø0.41" -0.001] | D3 | ø16 -0.08 [ø0.63" -0.003] |
| D4 | ø10.67 [ø0.42"] | D4 | ø16 -0.4 [ø0.63" -0.016] |
| D5 | ø12.7 [ø0.5"] | D5 | ø18 [ø0.71"] |
| A | 5.56 -0.26 [0.22" -0.01] | A | 6 -0.26 [0.24" -0.01] |
| B | 11.2 [0.44"] | B | 14.8 -0.4 [0.58" -0.016] |
| C | 15.74 [0.62"] | C | 19 [0.75"] |
| Ch [Hex] | 16 [5/8"] | Ch [Hex] | 19 [3/4"] |

NOTE: dimensions refer to rigid stem length option "4" (153 mm– 6")

WARNING: For installation use a maximum tightening torque of 56 Nm (500 in-lb)

MECHANICAL DIMENSIONS

HWX2

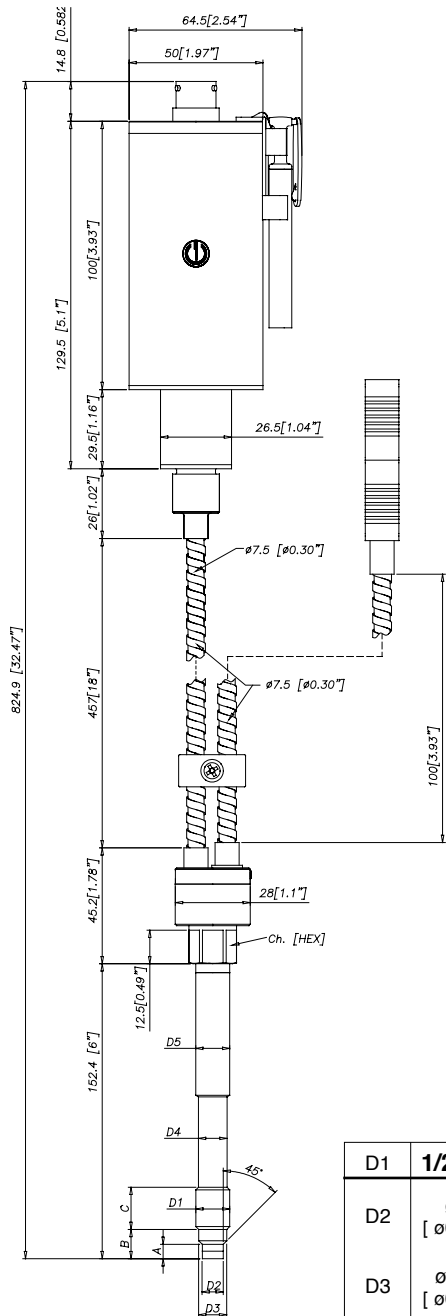

| D1 | 1/2 - 20UNF |
|-------------|--|
| D2 | $\phi 7.8 -0.05$ [$\phi 0.31 -0.002$] |
| D3 | $\phi 10.5 -0.025$ [$\phi 0.41 -0.001$] |
| D4 | $\phi 10.67$ [$\phi 0.42$] |
| D5 | $\phi 12.7$ [$\phi 0.5$] |
| A | $5.56 -0.26$ [$0.22 -0.01$] |
| B | 11.2 [0.44] |
| C | 15.74 [0.62] |
| Ch [Hex] | 16 [$5/8$] |

| D1 | M18x1.5 |
|-------------|--|
| D2 | $\phi 10 -0.05$ [$\phi 0.394 -0.002$] |
| D3 | $\phi 16 -0.08$ [$\phi 0.63 -0.003$] |
| D4 | $\phi 16 -0.4$ [$\phi 0.63 -0.016$] |
| D5 | $\phi 18$ [$\phi 0.71$] |
| A | $6 -0.26$ [$0.24 -0.01$] |
| B | $14.8 -0.4$ [$0.58 -0.016$] |
| C | 19 [0.75] |
| Ch [Hex] | 19 [$3/4$] |

HWX3

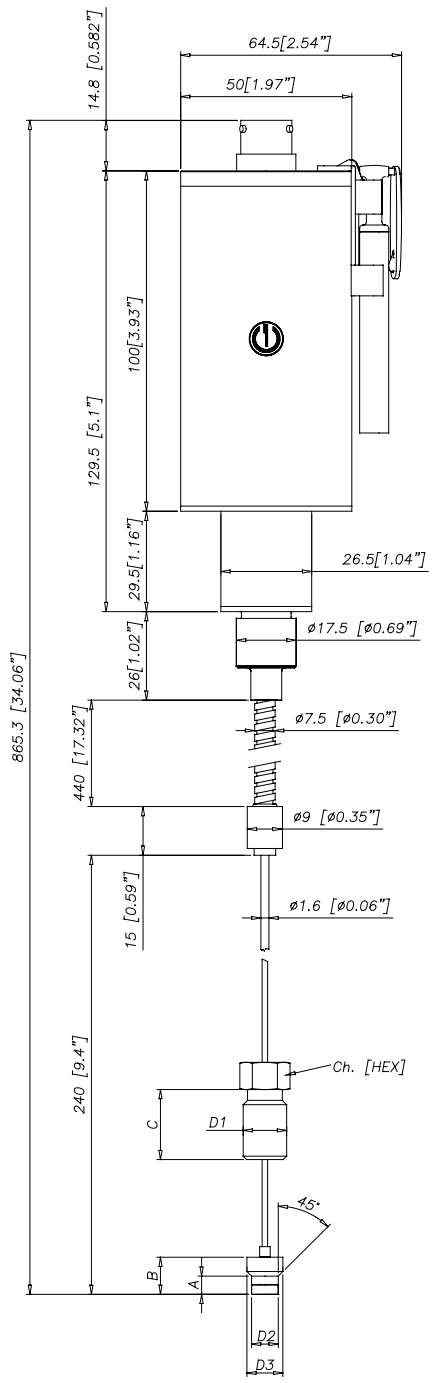

NOTE: dimensions refer to rigid stem length option "4" (153 mm– 6")

WARNING: For installation use a maximum tightening torque of 56 Nm (500 in-lb)

SELF DIAGNOSTICS (ONLY FOR PL'C' VERSIONS)

Below the conditions detected by the sensor self-diagnostics:

- Cut cable / device non connected / broken power supply, output $\leq 3.6\text{mA}$
- Pin detachment output $\leq 3.6\text{mA}$
- Broken primary element $\geq 21\text{mA}$
- Pressure above 200% of the span, output $\geq 21\text{mA}$
- Voltage monitor in case of overvoltage/undervoltage/voltage variation in the electronics, output $\leq 3.6\text{mA}$ (*)
- Program sequence error, output $\leq 3.6\text{mA}$ (*)
- Overtemperature on the electronics, output $\leq 3.6\text{mA}$ (*)
- Error on the primary element output or on the first amplification stage, output $\geq 21\text{mA}$

(*) In such conditions the Alarm Type can be programmed via HART at $\geq 21\text{mA}$.

NAMUR COMPLIANCE (ONLY FOR PL'C' VERSIONS)

The sensors are tested according to Namur NE21 recommendations. The same compatibility is valid for the NE43 Namur recommendation with the following sensor behaviour in case of breakdown:

- Cut cable: breakdown information as the signal is $\leq 3.6\text{mA}$
- Device not connected: breakdown information as the signal is $\leq 3.6\text{mA}$
- Broken power-supply: breakdown information as the signal is $\leq 3.6\text{mA}$
- or in case of performance problems:
- Broken primary element $\geq 21\text{mA}$
- Pressure above 200% of the span, output $\geq 21\text{mA}$
- Others $\leq 3.6\text{mA}$ (*)

(*) In such a condition the Alarm Type can be programmed via HART at $\geq 21\text{mA}$.

Note: in all the remaining situations, the output signal is always included between 3.8 and 20.5mA.



Recommendation: the error level set by the customer (e.g. maximum pressure value) has to be inside the nominal range.

LOAD DIAGRAM

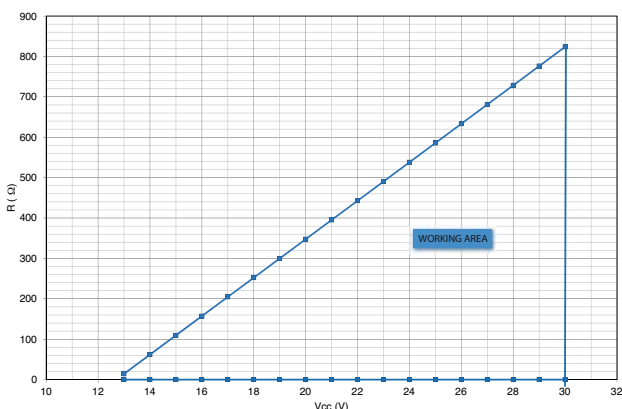

The diagram shows the optimum ratio between load and power supply for transmitters with 4...20mA output. For correct function, use a combination of load resistance and voltage that falls within the two lines in the graph above.

AUTOZERO FUNCTION

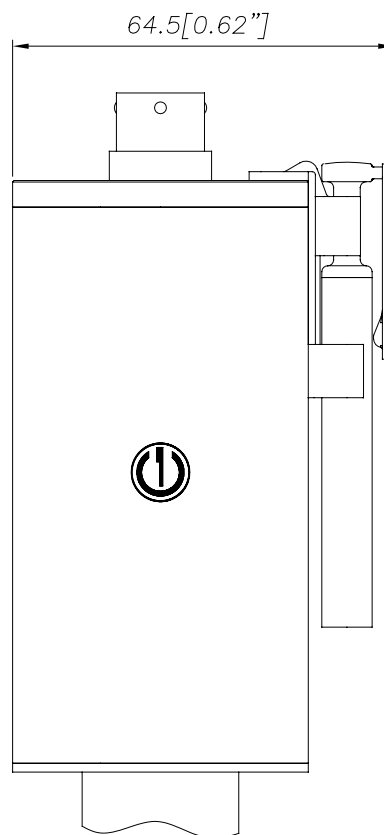

The Autozero function is activated through a magnetic contact (external magnet supplied with the sensor). The Autozero function can be activated through HART command as well. See the manual for a complete Autozero function explanation.

ELECTRICAL CONNECTIONS

CURRENT OUTPUT

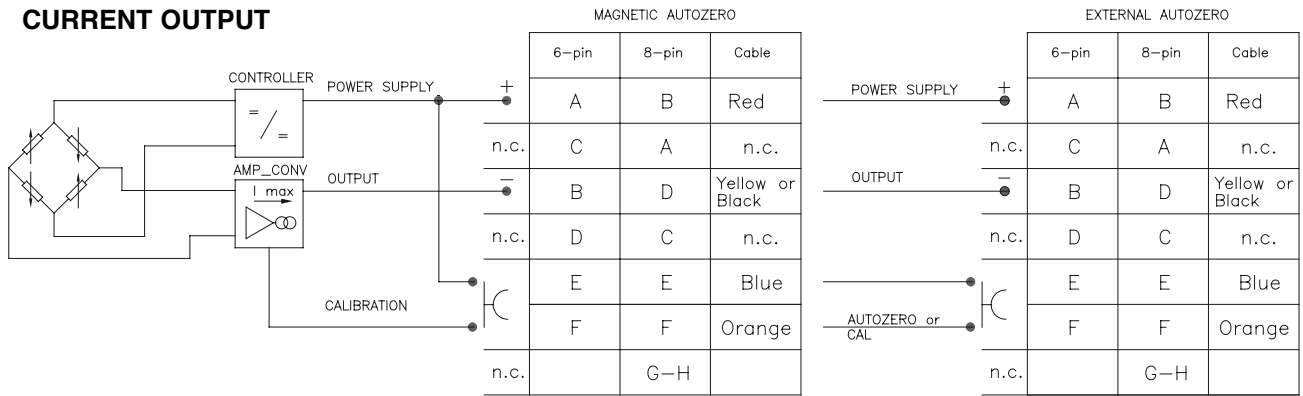

The cable shield is tied to both sides, i.e. to the sensor connector and to the controller

6 pin Connector VPT07RA10-6PT2 (PT02A-10-6P)

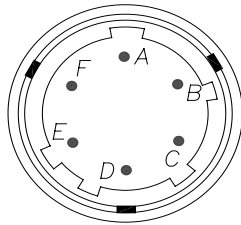

8 pin Connector (PC02E-12-8P) Bendix

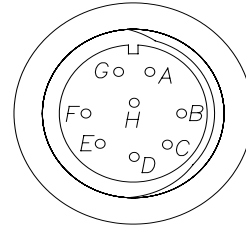

Cable outlet (1/2 14-NPT) Current output L = 1 m

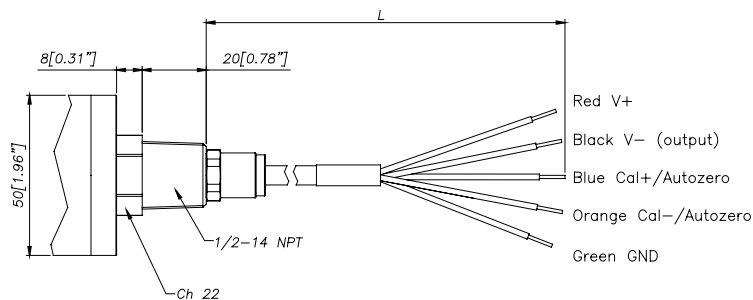

ACCESSORIES

Connectors

6-pin female connector (IP65 protection degree)
8-pin female connector

CON300
CON307

Accessories

Mounting bracket
Dummy plug for 1/2-20UNF
Dummy plug for M18x1.5
Drill kit for 1/2-20UNF
Drill kit for M18x1.5
Cleaning kit for 1/2-20UNF
Cleaning kit for M18x1.5
Fixing pen clip
Autozero pen

SF18
SC12
SC18
KF12
KF18
CT12
CT18
PKIT1032
PKIT378

Extension cables

6-pin connector with 3mt Atex cable
6-pin connector with 4mt Atex cable
6-pin connector with 5mt Atex cable
6-pin connector with 10mt Atex cable

PCAV221
PCAV104
PCAV105
PCAV106

Thermocouples for model HWX2

Type "J" (for rigid rod 153mm - 6")

TTER 601

| Cable color code | |
|------------------|--------|
| Conn. | Wire |
| A-2 | Red |
| B-4 | Black |
| C-1 | White |
| D-6 | Green |
| E-7 | Blue |
| F-3 | Orange |
| 5 | Grey |
| 8 | Pink |

ORDER CODE

HW - - - - - 0000 X 000 X 0

000= Special executions

| OUTPUT SIGNAL | |
|---------------|---|
| 4...20mA | X |

| VERSION | |
|----------------------|---|
| Rigid rod | 0 |
| Rigid + flexible rod | 1 |
| With thermocouple | 2 |
| Exposed capillary | 3 |

| CONNECTOR | |
|-----------|---|
| 6 pin | 6 |
| 8 pin | 8 |
| NPT Cable | N |

| ACCURACY CLASS | |
|---------------------------------------|---|
| 0.25% FSO (ranges ≥ 100 bar/1500 psi) | H |
| 0.5% FSO | M |

| MEASUREMENT RANGE | | | |
|-------------------|------|-------|------|
| bar | | psi | |
| 17 | B17U | 250 | P25D |
| 35 | B35U | 500 | P05C |
| 50 | B05D | 750 | P75D |
| 70 | B07D | 1000 | P01M |
| 100 | B01C | 1500 | P15C |
| 200 | B02C | 3000 | P03M |
| 350 | B35D | 5000 | P05M |
| 500 | B05C | 7500 | P75C |
| 700 | B07C | 10000 | P10M |
| 1000 | B01M | 15000 | P15M |

| THREADING | |
|--------------|---|
| Standard | |
| 1/2 - 20 UNF | 1 |
| M18 x 1.5 | 4 |

| | |
|---|--|
| 4 | T4 Ex ia IIC T4 Ga (Tambient: -20°C...+85°C)/Ex ia IIIC T135°C Da IP65 |
| 5 | T5 Ex ia IIC T5 Ga (Tambient: -20°C...+75°C)/Ex ia IIIC T100°C Da IP65 |
| 6 | T6 Ex ia IIC T6 Ga (Tambient: -20°C...+60°C)/Ex ia IIIC T85°C Da IP65 |

| | |
|---|-----------------------|
| E | External Autozero (*) |
| 0 | Magnetic Autozero |
| (*) as an alternative to the CAL function | |

| | |
|---|-----------------------|
| P | Performance Level='c' |
| 0 | Standard 4...20mA |

FLEXIBLE ROD LENGTH (mm/inches)

| Standard (HWX0) | |
|-----------------|------|
| 0 | none |

| Standard (HWX1, HWX2) | |
|-----------------------|-----------|
| D | 457mm 18" |
| E | 610mm 24" |
| F | 760mm 30" |

| Standard (HWX3) | |
|-----------------|-----------|
| L | 711mm 28" |

| Available on request | |
|----------------------|------------|
| A | 76mm 3" |
| B | 152mm 6" |
| C | 300mm 12" |
| G | 914mm 36" |
| H | 1067mm 42" |
| I | 1220mm 48" |
| J | 1372mm 54" |
| K | 1520mm 60" |

RIGID ROD LENGTH (mm/inches)

| Standard (HWX0, HWX1, HWX2) | |
|-----------------------------|-------------|
| 4 | 153mm 6" |
| 5 | 318mm 12.5" |

| Standard (HWX3) | |
|-----------------|------|
| 0 | none |

| Available on request | |
|----------------------|-----------|
| 1 | 38mm 1.5" |
| 2 | 50mm 2" |
| 3 | 76mm 3" |
| 6 | 350mm 14" |
| 7 | 400mm 16" |
| 8 | 456mm 18" |

Example

HWX1-6-M-B07C-1-4-D-0-0-4

Melt pressure transmitter, 4...20mA output with HART protocol, 6-pin connector, 0.5% accuracy, 700 bar pressure range, 1/2-20 UNF threading, 153 mm (6") rigid rod, 457 mm (18") flexible rod, T4 temperature class (-20°C...+85°C).

Sensors are manufactured in compliance with:

- EMC 2004/108/CE compatibility directive
- RoHS 2002/95/CE directive
- ATEX 94/9/CE directive
- 2006/42/CE machinery directive

Electrical installation requirements and conformity certificate are available on our web site: www.gefran.com

GEFRAN spa reserves the right to make any kind of design or functional modification at any moment without prior notice.

GEFRAN spa
 via Sebina, 74
 25050 PROVAGLIO D'ISEO (BS) - ITALIA
 tel. 0309888.1 - fax. 0309839063
 Internet: <http://www.gefran.com>

GEFRAN

DTS_HWX_02-2016_ENG